

ecoline™



eSense™
counterbalance solution

stability +
efficiency

SUN hydraulics®

A HELIOS TECHNOLOGIES COMPANY

Save energy *without* sacrificing performance with eSense™

In collaboration with Purdue University, Sun Hydraulics has created the next generation of load-holding technology. Part of the new ecoline™ program, eSense™ is the efficient and innovative solution the world has been waiting for. This powerhouse solution adapts to any load and provides up to **85% of energy-efficient power** to your application. Combatting the industry's ongoing challenge for shock absorption, eSense™ provides up to **90% less oscillation**. Resilient and compact, this low-leakage solution is optimized for the user's smooth control and safety.

eSense™

featuring the
uControl™ Mobile
Controller from
Enovation Controls

- Multiple CAN interfaces
- High-current output option
- IP69K sealed
- High heat, high-vibration resistance

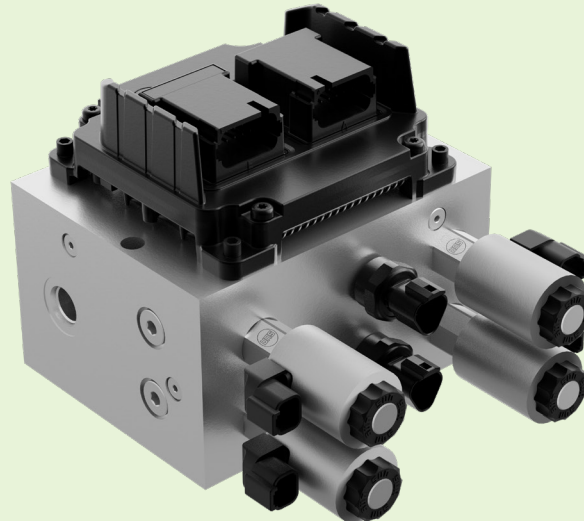

Includes wiring harness

STABILITY + EFFICIENCY in counterbalance

eSense™ example schematic:

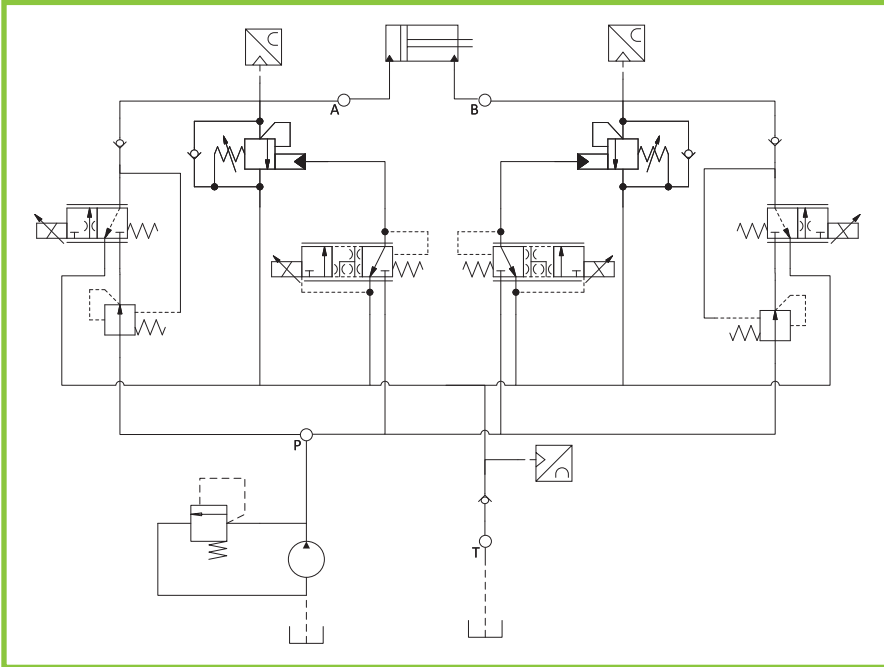

Possible Applications

- Hydraulic Press
- Gantry crane
- Planter
- Material handling machine
- Crane
- Scissor lift

eSense™ example results versus standard counterbalance:

Main Boom Extension

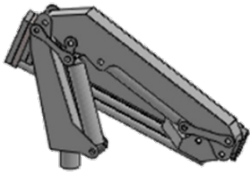

85% Energy Savings
15% Less Oscillation

Main Boom Retraction Outer Boom Folded

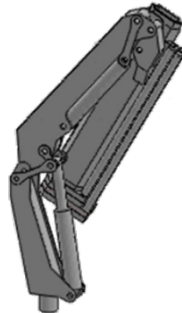

78% Energy Savings
1% More Oscillation

Main Boom Retraction Outer Boom Unfolded

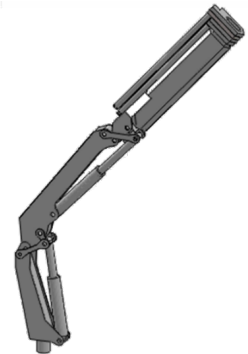

84% Energy Savings
89% Less Oscillation

from the World Leader
valve technology.

about ecoline™

As a leading manufacturer of high-performance cartridge valves and integrated packages, Sun Hydraulics has gathered a collection of innovative solutions proven to significantly boost and improve energy efficiency, reduce fuel consumption, and ultimately provide cost savings for the end user.

Sun's new ecoline™ program is comprised of popular products such as the LoadMatch™ cartridge valve, LoadAdaptive™, Series 4 PLUS cartridges, T-18AU & T-19 AU cavities, Sun Cavity & QuickDesign™, Energen and the latest ecofriendly addition, the eSense™ solution. Contact us to learn more about ecoline™ and how these products can optimize the efficiency of your application.



A HELIOS TECHNOLOGIES COMPANY

 Sarasota, Florida USA

 +1 941 362 1200

 www.sunhydraulics.com